









5 STAR RHEEM 265/295 GAS STORAGE WATER HEATER

					
GAS	5 STAR	PEOPLE	FIRST HOUR CAPACITY	WARRANTY ¹	



FEATURES

- **5 Star energy efficiency** – uses less gas than 3 or 4 Star water heaters, so saves on home gas bills
 - **Mains pressure** at multiple taps – to service multiple hot water demands at once
 - **Strong recovery** – to have you back in hot water fast
 - **272L or 302L first hour capacity** of hot water
 - **Compact size** – 485mm diameter, for easy replacement of existing 3 star gas water heaters
 - 5 Year Warranty¹
- **RheemPlus[®] 265/295 models available**
 - 50°C Temperature limited
 - Adjustable to deliver higher temperatures (complying with AS 3498)
 - No tempering valve required²

WHY CHOOSE RHEEM GAS STORAGE HOT WATER?

- Designed for Australia's tough conditions, using over 70 years of experience
- Capacities to suit family sizes and hot water requirements
- Fast hot water recovery
- Mains pressure water delivery for steady, hot and strong hot water
- Full technical support through Rheem's National Service Network
- Available to suit Natural Gas or Propane



COMES ON STEADY, HOT AND STRONG

INSTALL A





5 STAR RHEEM 265/295 GAS STORAGE WATER HEATER

MAINS PRESSURE HOT WATER WHEN YOU NEED IT

Mains pressure gas storage water heaters are your guarantee of consistent hot water. You can be sure of a strong flow of hot water, even to multiple taps at once.

Rheem's modern design complements any home. And Rheem 5 Star energy efficient Gas Storage water heaters are good for the environment.

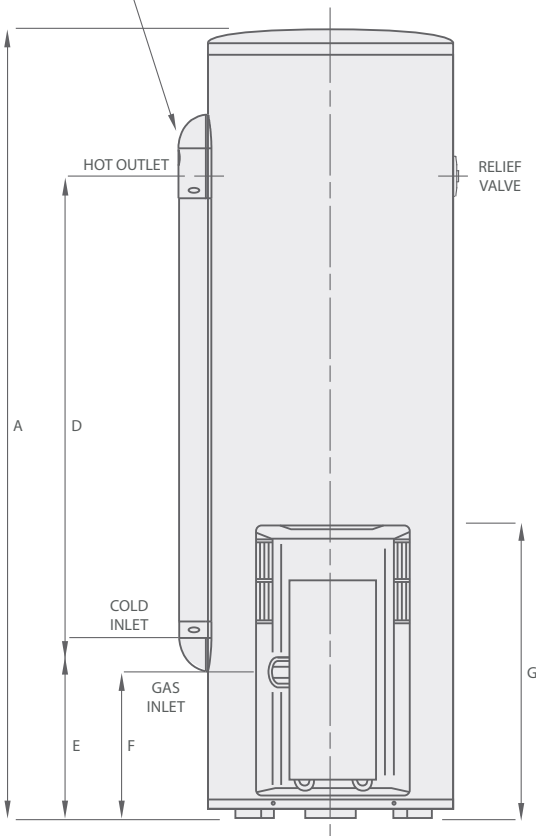
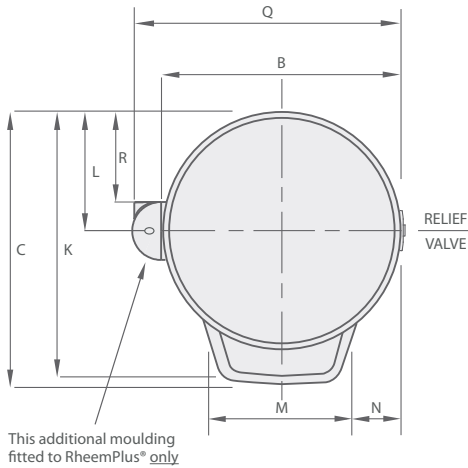

MODEL	RHEEM 5 STAR		
	265	295	
Rheem 5 Star	350265	350295	
RheemPlus® 5 Star (50°C limited) ²	354265	354295	
Suitable for no. of people			
Moderate Climate	2-4	3-5	
Cool Climate	2-3	3-4	
Warranty ¹	5 Years	5 Years	
Gas Type	Natural Gas /Propane		
Gas Energy Rating	5.3	5.3	
Storage Capacity	Litres	130	160
Recovery Rate @ 45°C	L/hr	142	142
First Hour Capacity	Litres	272	302
Hourly Gas Consumption Natural Gas	MJ	30	30
Dimensions			
A	mm	1622	1922
B	mm	485	485
C	mm	556	556
D	mm	988	1213
E	mm	328	409
F	mm	298	298
G	mm	600	600
K	mm	520	520
L	mm	240	240
M	mm	297	297
N	mm	97	97
Q (RheemPlus® only)	mm	545	545
R (RheemPlus® only)	mm	182	182
Weight Empty	kg	75	85
Relief Valve Setting	kPa	1400	1400
Expansion Control Valve (ECV) Setting	kPa	1200	1200
Max. Water Supply Pressure			
with ECV	kPa	960	960
without ECV	kPa	1120	1120
Water Connection		RP ¾/20	RP ¾/20
Gas Connection		RP ½/15	RP ½/15

¹ Warranty: 5 Years on Cylinder, 3 Years Labour on Cylinder, 1 Year Parts & Labour warranty on all other components for Domestic (non-Commercial) installations.
² 50°C factory pre-set models supply hot water at a maximum 50°C at all outlets in accordance with AS 3498. Some applications may require tempering, refer to AS 3500.4.
³ Registered Trademark of Rheem Australia Pty Ltd.
 Materials and data are subject to change without notice.



Rheem Australia Pty Ltd.
 1 Alan Street, Rydalmere, New South Wales 2116, Australia
 PO Box 6, Rydalmere, New South Wales 2116, Australia.